

FALCON GUN PORTS

For DeAgostini Kit ISSUES 41 AND 44



ParaGrafix states that our use of the trademarked terms listed below in our product descriptions constitutes fair use and nominative use and is in no way to offer confusion that ParaGrafix and any of the following noted trademark holders are related companies, nor do we state that we are endorsed by these trademark holders. We are an AFTERMARKET company acting in GOOD FAITH in providing high quality products to loyal customers who have already purchased products related to these trademarks. ParaGrafix is actually providing these trademark holders a venue of free advertising and indirectly provide these trademark holders with more sales leads.
 © & TM 2015 Lucasfilm LTD. © & TM DeAgostini Publishing USA Inc., DeAgostini Editore S.p.A.

INTRODUCTION

Thank you for purchasing ParaGrafix's gun port upgrade set for the Millennium Falcon subscription kit from DeAgostini Publishing. This set is intended for modelers of moderate experience who are experience with photoetched parts.

Please note that these instructions replace some of the kit's instructions for assembling the hold. It is suggested that you familiarize yourself with all aspects of the assembly before proceeding.

NOTE: Contains enough parts to complete BOTH gun ports. REPEAT ALL INSTRUCTIONS TWICE.

Materials

In addition to the photoetch, you will also need scissors or a knife* to remove individual pieces from the main fret, a file to remove material left from cutting, and super glue (aka CA or cyanoacrylate). Additionally, to fold some pieces, you will need a pair of razor blades** or a specialty tool such as PhotoFold from ParaGrafix.

* We prefer a #17 Xacto chisel blade in combination with a glass cutting board or other, similarly hard cutting surface.

** Extreme care must be taken when using razor blades. Risk of serious injury.

Installation Parts Order

The installation steps are not in any particular order. You can complete them as you see fit to complement your kit construction order.

Key

- Kit part (plastic): **1**
- Photoetched part: **1**
- Decal: **A**

Decals and Photoetch Relief

Photoetch Relief

Apply the photoetched relief pieces (1, 2, 4, and 5) to the main gun port well (3) in the positions shown. Note that there are thin engraved lines to aid in alignment.

(There are many extra parts 2 as this detail is used in several locations throughout the Falcon's interior sets.)

Decals

TIP: You may find it better to wait until after you have assembled parts 1, 7 and 8 (which is detailed on the next page) before completing this step. This is especially true if you plan on soldering your parts as the heat will destroy the paint and decals.

Paint the gun port with your choice of base color. The relief pieces are contrasting colors – black for parts 2 and metallic for parts 1, 4, and 5.

Fill in the control panel holes in part 3 using Micro Krystal Klear, or similar product. (Do not fill the two large holes below the large circular opening in the center of part 2 as this is where the ladder goes.)

You can add color to particular buttons using clear paint made to tint car model tail lights, painted on the back-side of the part.

Apply the decals in the locations shown.

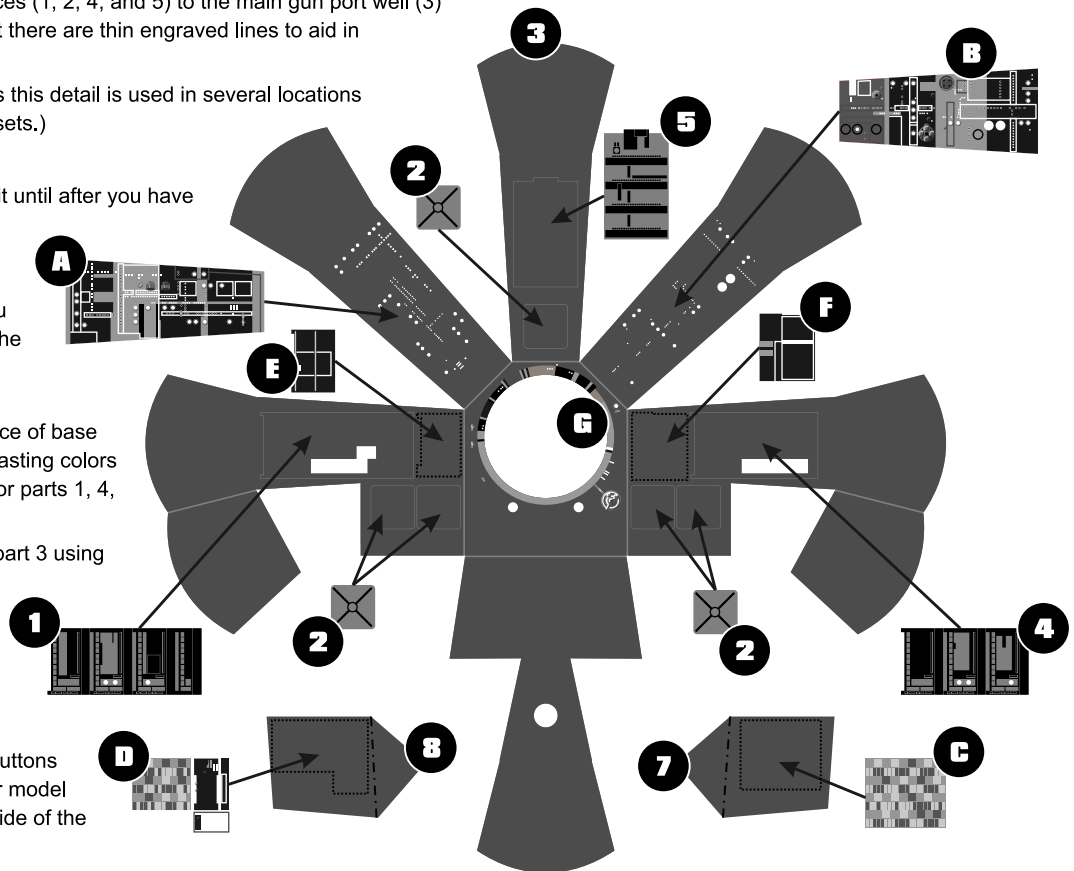

Step, "Notches", and Headsets

Fold the step (part 9) and the "notches" (parts 7 and 8) as shown. Note that parts 7 and 8 are shown from the back side, i.e. the side without details. Four headsets (6) are included. Only 2 are needed, the other 2 are extras. Simply round the head strap and microphone as shown and place in the cockpit.

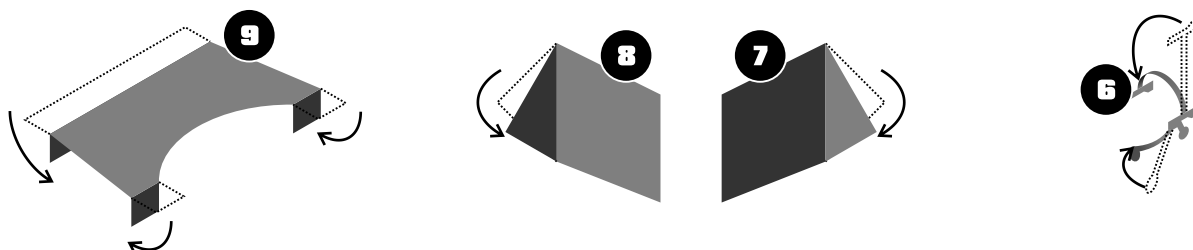

Main Assembly

Fold the outer "petals" of the gun port back by about 38° as shown at right α

Fold the inner "petals" inward until they all meet up (β). Note that you may have to fiddle with the outer petals to get everything to match up.

Attach parts 7, 8, and 9 (δ). See finished assembly at Ω .

Assemble the gunnery chair per the kit's instructions and mount it

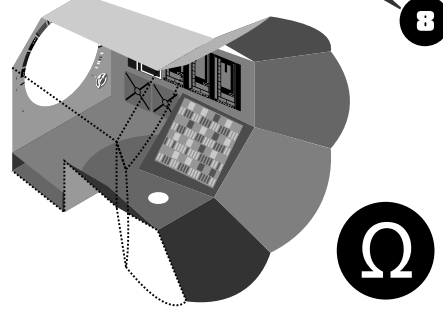
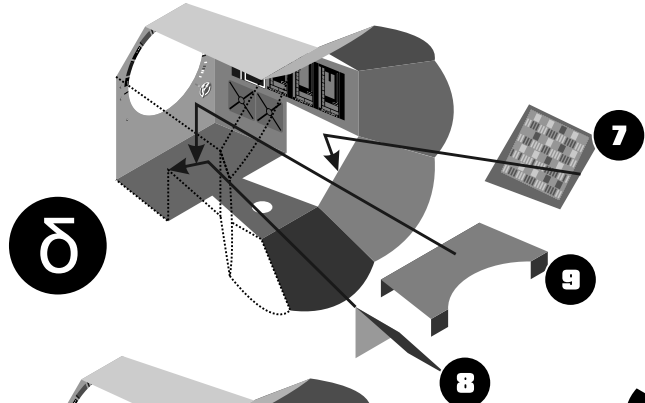
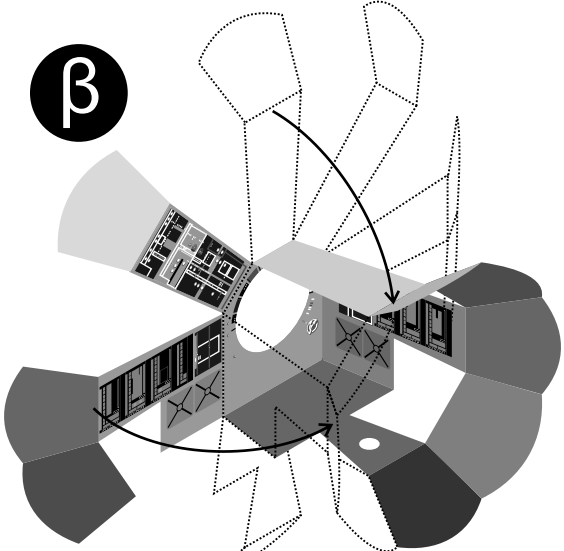
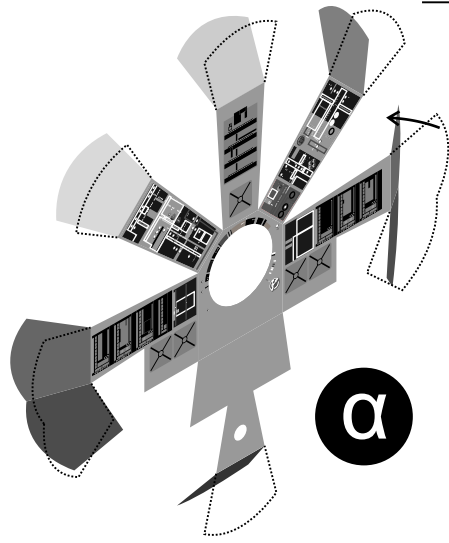
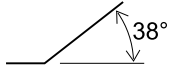

Mount to Kit

Attach each gun port set into the gun ring as shown below. Align the notch in part 10 with the tab on the inner ring as shown at the bottom. The central flat portion will now align with the "floor" of gun port.

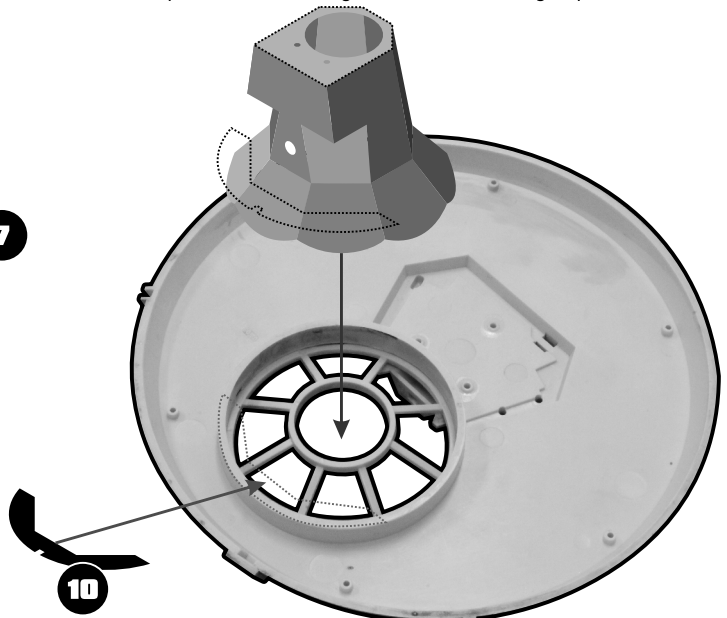

Ladder & Access Tube Mounting

At this time, we are not sure how the ladder and access tube will mount. We will update these instructions online when this becomes clear and any steps necessary will be added.

DECAL INSTRUCTIONS

Decals are best applied to a glossy surface. Apply glossy paint or spray a clear gloss coating on your model before applying decals. Carefully cut out the decal from the sheet and, using tweezers, dip the decal into plain water for 5 seconds or until the blue backing changes to a darker blue.

WARNING:

Leaving the decal in the water too long may result in the glue washing off the decal. Lay the decal on your work surface for 30 seconds, and then slide the decal off the backing paper into position on your model. Gently blot the excess water. Allow to dry. Once the decals have dried thoroughly, you can use a sharp knife to gently cut and remove the excess decal film. Apply a second coat of clear finish over the model to seal the decals.

A decal set may be used to help the decal conform to irregular surfaces and hides the decal film. This makes the artwork appear to be painted on the model, rather than applied by decal. Another method used is to create an equal mixture of water and white glue (Elmer's). Using a brush, apply the mixture to the surface. While still wet, apply the decal. The glue will help the decal adhere to the surface and will dry clear. Once dry, wet a Q-tip and remove any excess glue from the model and decal by brushing out from the center of the decal. Brushing into the center may cause the decal edge to lift.

Important: Please Read

The JT-Graphics decals you have purchased are coated with Testor's Clear Flat Lacquer. Using an Enamel clear coat such as Krylon or Rustolium may cause damage to the decal.

A known fact is that you can apply lacquer over enamel, but not enamel over lacquer. Therefore, it is suggested that after applying the decals, you only coat (seal) your model with a lacquer clear coat to avoid damaging the decals. Acrylic enamel may not react to the lacquer, but it has not been tested. Another suggestion is to use a piece of the decals, (such as the JT-Graphics logo or an optional decal you do not plan on using) and test it. Apply your test decal to a painted surface similar to the one you will be applying to and test it against the clear coat you wish to use.

Besides using Testor's Clear lacquer as a sealer, you can also use Future Floor Wax as a clear coat.

Any problems or Questions contact:

Jeffrey Waclawski 410-574-3220

info@jt-graphics.com



104 County Street, Suite 101
Attleboro MA 02703 USA
+1 508-431-9800
www.ParaGrafix.biz